

Technical data sheet

Progressive cavity pumps VISCOPOWER F 570 / F 580



More than just pumps



Advantages/features:

- ▶ Easy and fast disassembling of the wetted parts
- ▶ For operation in the food, cosmetics or pharmaceutical industry – version conforming to FDA and EC 1935/2004 available
- ▶ Standardized interfaces, modular system
- ▶ Wide range of applications



A wide range of preconfigured variants is already available for the most common applications and fields of use. For specific needs, media or special applications, the pump can be assembled from various modular building blocks tailored to your requirements.

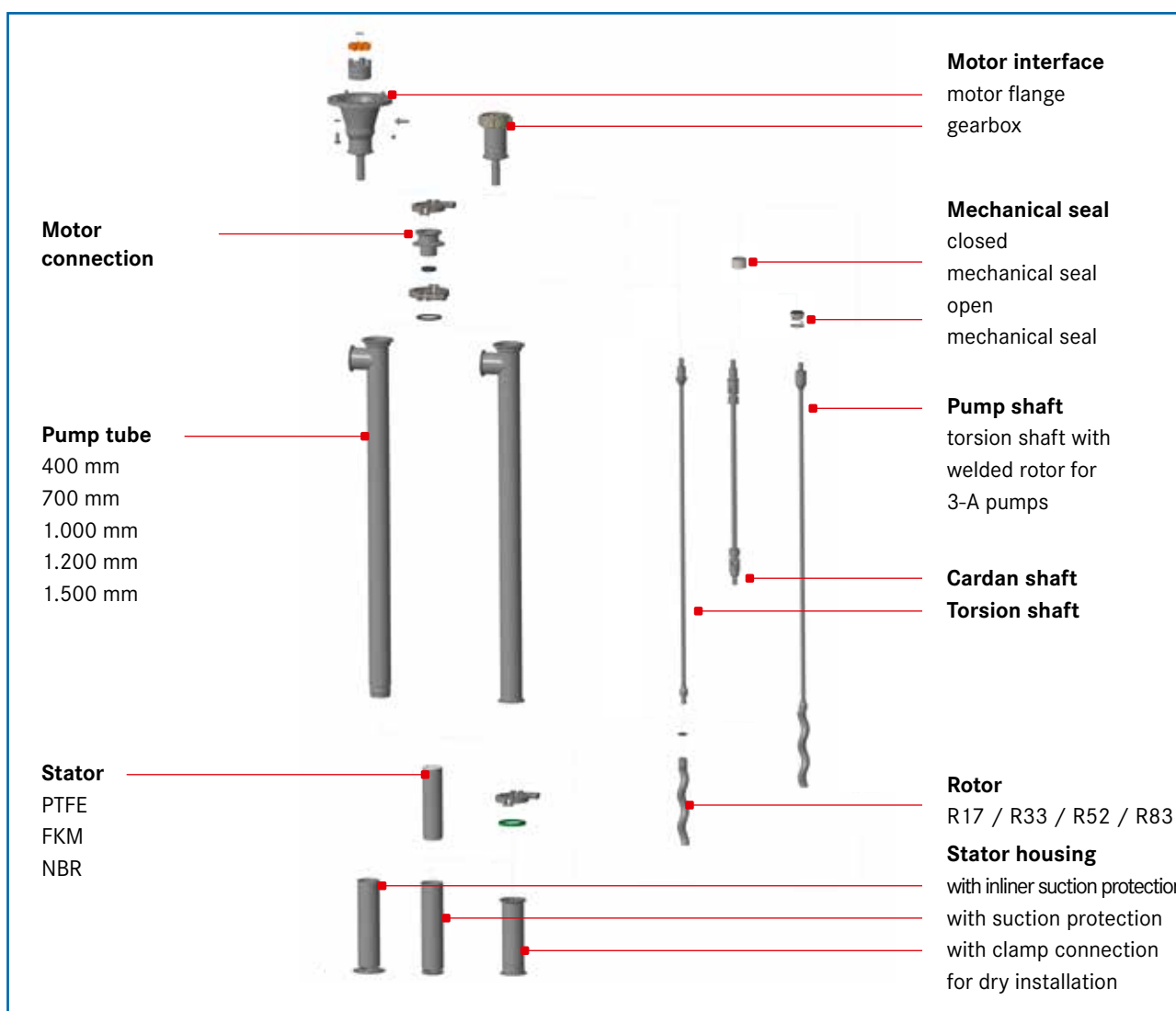

Components

VISCOPOWER

Motor connection

F 570: gearbox variant

i = 16 gearbox

- double stage gearbox
- for use with air motors, commutator motors or brushless motors
- for media up to max. 30.000 mPas (depending on motor)
- lightweight – for mobile use

i = 7 gearbox

- single-stage gearbox
- for high-speed asynchronous motors
- for media up to 80.000 mPas
- with anti-rotation device to prevent the motor from rotating due to vibrations



F 580: motor flange variant

- for use with asynchronous motors, spur gear motors, air motors
- for thin to highly viscous, pasty media up to 100.000 mPas
- robust
- for stationary use
- in combination with VISCOFLUX mobile S also suitable for media that are not capable of flowing
- available with speed sensor for indirect, non-contact flow measurement



Pump tube

material	stainless steel (1.4404)
outer diameter [mm]	53
outlet connection	clamp 2"
immersion depth [mm]	400, 700, 1.000, 1.200, 1.500
connection stator housing	thread Rd 51 x 1/8 LH for vertical use in extraction container – as drum pump 2" clamp connection for dry installation outside the container or in connection with a drum emptying system VISCOFLUX mobile S



Stator housing

Stator housing with suction protection

connection to pump tube by thread Rd 51 x 1/8 LH



Stator housing with inliner suction protection

connection to pump tube by thread Rd 51 x 1/8 LH



Stator housing for dry-installed pumps

connection to pump tube by clamp 2"



Components

VISCOPOWER

Mechanical seal

Sliding ring and counter ring made of silicon carbide, spring made of stainless steel

	Open mechanical seal	Closed mechanical seal
seal	FKM	FKM or FFKM
pressure [bar]	max. 10	max. 15
use / application	for industrial applications	for hygienic applications
approvals	-	FDA



Seal materials (O-rings)

	FKM	NBR	FFKM
characteristics	general good chemical resistance	for mineral oils	for highest chemical resistance
approvals	FDA	-	FDA

Pump shaft

	Torsion shaft	Cardan shaft
for pumps with immersion depths [mm]	700 (max. 4 Nm) 1.000 1.200 1.500	400 700 (from 4 Nm)

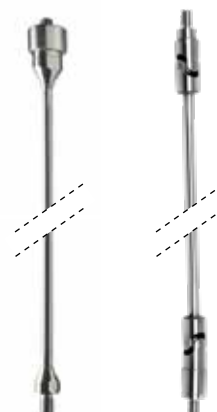

Rotor /stator geometry

	R17	R33	R52	R83
max. flow rate [l/min] at 900 rpm	15	30	47	75
nominal volume per rotation [ml]	17	33	52	83



Stator materials

	PTFE	NBR white	FKM
characteristics	very good chemical resistance, ideal for food as well as for pharmaceutical and cosmetic products	for fuels, mineral oils, greases, vegetable and animal fats and oils, diluted acids, bases and salt solutions	very good chemical resistance
approvals	FDA	FDA	-

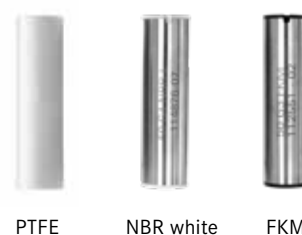

Pumps

VISCOPOWER F 570

F 570 - gearbox i = 16

VISCOPOWER pumps F 570 - with double stage gearbox i = 16

Open mechanical seal, FKM seal, torsion shaft

immersion depth [mm]	rotor geometry	stator material	part no.
700	R33	PTFE	12-570 00 001
700	R52	PTFE	12-570 00 004
1.000	R17	PTFE	12-570 00 007
1.000	R33	PTFE	12-570 00 002
1.000	R52	PTFE	12-570 00 005
1.000	R83	PTFE	12-570 00 009
1.200	R17	PTFE	12-570 00 008
1.200	R33	PTFE	12-570 00 003
1.200	R52	PTFE	12-570 00 006
1.200	R83	PTFE	12-570 00 010



Open mechanical seal, NBR seal, torsion shaft

immersion depth [mm]	rotor geometry	stator material	part no.
1.000	R33	NBR hell	12-570 00 011
1.000	R52	NBR hell	12-570 00 013
1.200	R33	NBR hell	12-570 00 012
1.200	R52	NBR hell	12-570 00 014

Closed mechanical seal, FKM seal, torsion shaft



immersion depth [mm]	FOOD	rotor geometry	stator material	part no.
1.000	Ja	R33	PTFE	12-570 00 015
1.000	Ja	R52	PTFE	12-570 00 017
1.200	Ja	R33	PTFE	12-570 00 016
1.200	Ja	R52	PTFE	12-570 00 018

Drive motors

for VISCOPOWER F 570

Appropriate drive motors for VISCOPOWER F 570 with double stage gearbox i = 16

Motors 230 V, 50 Hz, 5 m cable and plug



Commutator motor
FEM 4070



Commutator motor
F 457



Commutator motor
F 458 / F 458-1 /
F 458 EL



Commutator motor
F 460 Ex / F 460-1 Ex /
F 460 Ex EL



Brushless motor
FBM 4000 Ex

F 570 – gearbox i = 16

type	capacity [watt]	protection class	max. viscosity [mPas]	weight [kg]	part no. with no-volt release	part no. without no-volt release
FEM 4070	500	IP 24	10.000	2,6	10-407 01 000	10-407 01 001
F 457	800	IP 24	30.000	4,0	10-457 01 005	10-457 01 002
F 458	460	IP 55	12.000	5,1	10-458 00 006	10-458 00 001
F 458 EL*	460	IP 55	12.000	5,1	10-458 00 027	-
F 458-1	700	IP 55	25.000	5,9	10-458 01 004	10-458 01 001
F 460 Ex	460	IP 55	12.000	5,1	10-460 00 006	10-460 00 001
F 460 Ex EL*	460	IP 55	12.000	5,1	10-460 00 028	-
F 460-1 Ex	700	IP 55	25.000	5,9	10-460 01 004	10-460 01 001
FBM 4000 Ex	600	IP 55	20.000	6,1	10-400 01 000	10-400 01 000

EL* = version with electronic speed adjustment

Compressed-air motors explosion-proof, max. operation pressure 6 bar, G ¼" female connection for air hose



F 416 Ex



F 416-1 Ex



F 416-2 Ex

type	capacity [watt]	max. viscosity [mPas]	version	weight [kg]	part no.
F 416 Ex	470	30.000	with tilt valve	1,4	10-416 00 100
F 416-1 Ex	470	30.000	without valve	0,9	10-416 00 020
F 416-2 Ex	470	30.000	with ball valve	1,0	10-416 00 030

accessories	part no.
filter-regulator-lubricator unit, G ¼" female connection, for non-hazardous areas	10-001 10 100
filter-regulator-lubricator unit, G ¼" female connection, explosion-proof	10-001 10 113
compressed-air hose, electrically conductive, DN 10, sold by meter	10-001 10 098
hose coupling in brass, for hose DN 10	10-959 13 066
threaded nipple in brass for hose coupling, G ¼" male	10-959 13 065
hose nozzle in brass for air hose DN 10 – G ¼" male	10-959 05 022
plug-in sleeve DN 10	10-959 13 209
1-ear hose clip ø 14,8; clamping range 8 - 18 mm	10-959 13 237

Further accessories for drive motors can be found in our detailed FLUX Accessories brochure.

Pumps and drive motors

VISCOPOWER F 570

F 570 – gearbox i = 7

VISCOPOWER pumps F 570 - with single-stage gearbox i = 7

Open mechanical seal, FKM seal, torsion shaft

immersion depth [mm]	rotor geometry	stator material	part no.
1.000	R33	PTFE	12-570 00 024
1.000	R52	PTFE	12-570 00 023



Appropriate motors F 403

Single phase AC motor, 230 V, 50 Hz, IP 55, with motor protection switch, 5 m cable and plug

rpm	capacity [kW]	weight [kg]	part no.
3.000	0,5	9,0	10-403 01 023
1.500	0,55	11,0	10-403 01 024



image similar

Three-phase motor, 230/400 V, 50 Hz

	rpm	capacity [kW]	weight [kg]	part no.
motor protection switch	1.500	0,55	8,7	10-403 01 025
motor protection switch	3.000	0,75	10,2	10-403 01 026
cable terminal box	1.500	0,55	12,0	10-403 01 027 ¹
cable terminal box	3.000	0,75	13,7	10-403 01 029 ¹

¹ Ex II 2G Ex eb IIC T3 Gb

Pumps

VISCOPOWER F 580

VISCOPOWER pumps F 580 - with motor flange

Open mechanical seal, FKM seal

immersion depth [mm]	rotor geometry	connection pump tube	stator material	shaft	part no.
700	R33	thread	PTFE	cardan	12-580 00 001
700	R52	thread	PTFE	cardan	12-580 00 004
1.000	R33	thread	PTFE	torsion	12-580 00 002
1.000	R52	thread	PTFE	torsion	12-580 00 005
1.000	R83	thread	PTFE	torsion	12-580 00 007
1.200	R33	thread	PTFE	torsion	12-580 00 003
1.200	R52	thread	PTFE	torsion	12-580 00 006
1.200	R83	thread	PTFE	torsion	12-580 00 008



F 580

Open mechanical seal, NBR seal, torsion shaft

immersion depth [mm]	rotor geometry	connection pump tube	stator material	part no.
1.000	R17	clamp	NBR white	12-580 00 009
1.000	R33	thread	NBR white	12-580 00 011
1.200	R17	clamp	NBR white	12-580 00 010
1.200	R33	clamp	NBR white	12-580 00 012

Closed mechanical seal, FKM seal



immersion depth [mm]	FOOD	rotor geometry	stator material	shaft	weight [kg]	part no.
1.000	yes	R52	PTFE	torsion	7,0	12-580 00 013
1.200	yes	R52	PTFE	torsion	7,0	12-580 00 014

VISCOPOWER pumps immersion depth 400 mm, cardan shaft, PTFE stator, with clamp 2" connection at the stator housing for dry installation, e.g. assembly on pump trolley or console

immersion depth [mm]	rotor geometry	mechanical seal	FOOD	weight [kg]	part no.
400	R52	FKM open	no	7,0	12-580 00 019
400	R52	FKM closed	yes	7,0	12-580 00 020 





Drive motors

VISCOPOWER

F 580

Appropriate drive motors for VISCOPOWER F 580 – with flange connection

Three-phase motor, 230/400 V, 50 Hz

	rpm	capacity [kW]	protection class	weight [kg]	part no.
motor protection switch	750	0,75	IP 55	21,5	10-001 01 590
motor protection switch	750	1,1	IP 55	23,0	10-001 01 591
motor protection switch	1.000*	0,75	IP 55	16,5	10-001 03 443
motor protection switch	1.000*	1,1	IP 55	25,0	10-001 03 445
cable terminal box	750	0,75	IP 55	22,5	10-001 01 588
cable terminal box	750*	1,1	IP 55	22,5	10-001 01 589
cable terminal box	1.000*	0,75	IP 55	19,0	10-001 03 442
cable terminal box	1.000*	1,1	IP 55	23,0	10-001 03 444
cable terminal box	750	0,95	IP 55	28,0	10-001 01 592 
cable terminal box	1.000	0,75	IP 55	19,0	10-001 01 119 
cable terminal box	1.000	1,1	IP 55	19,0	10-001 01 120 

Ex-marking : Ex II 2G Ex eb IIC T3 Gb



image with cable terminal box - similar

Spur gear motor, 380 - 500 V, 50/60 Hz, 1,6 A, without foot flange

	rpm	capacity [kW]	protection class	weight [kg]	part no.
with frequency regulation	47 - 472	0,55	IP 54	12,2	10-001 02 178



Start / stop switch for spur gear motor with frequency regulation and attached set point adjuster

	part no.
switching voltage 24 V DC, IP 66, with 1 m spirale cable with Hirschmann plug	10-936 00 040



image similar

Compressed-air motor, explosion-proof, with silencer

	rpm	capacity [kW]	weight [kg]	part no.
FPM 4 Ex 	1.000	0,6	4,7	10-001 04 000
FPM 6 Ex 	1.000	1,2	6,6	10-001 04 014
FPM 8 Ex 	1.000	2,0	11,3	10-001 04 002



FPM 4 Ex

* efficiency class IE3
version in stainless steel on request

Dimensions

VISCOPOWER

Pump tube

outer diameter pump tube [mm]	length stator housing [mm]	outlet connection
53	with thread connection: 224 with clamp connection: 214	clamp DN 50 / 2" (acc. to DIN 32676)

Total lengths

immersion depth [mm]	gearbox variant F 570 i = 16	gearbox variant F 570 i = 7	motor flange variant F 580
400	610,3 (TR - clamp)	590,3 (TR - clamp)	638 (TR - clamp)
700	920,3	900,2	948
1.000	1.220,3	1.200,3	1.248
1.200	1.420,3	1.400,3	1.448
1.500	1.720,3	1.700,3	1.748

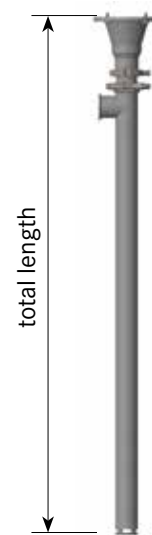

Dimensions

Drive motors for F 570 VISCOPOWER pumps with double stage gearbox i = 16

All dimensions in mm. When motor and pump are mounted, the total height is reduced by 16 mm.

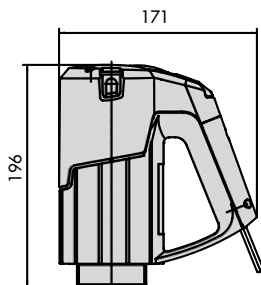

FEM 4070

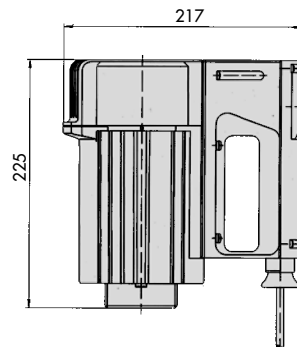

F 457

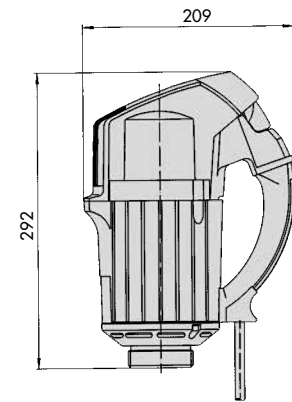

F 458/F 458 EL/F 458-1/
F 460 Ex/F 460 Ex EL/
F 460-1 Ex
FBM 4000 Ex

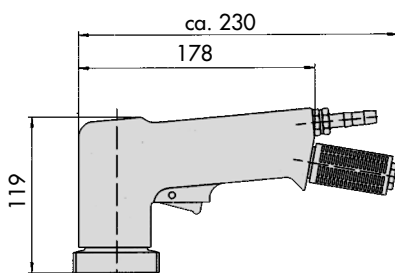

F 416 Ex

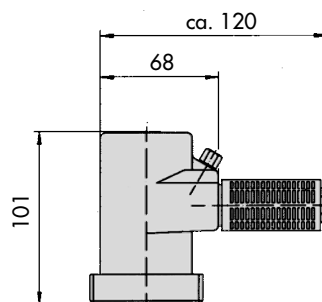

F 416-1 Ex

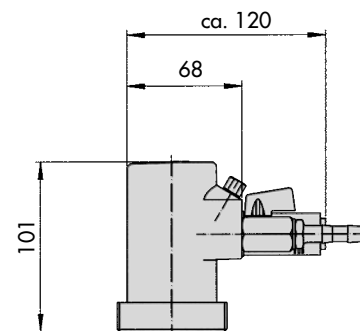

F 416-2 Ex

Dimensions



Drive motors for F 580 VISCOPOWER pumps with motor flange

Three-phase motors

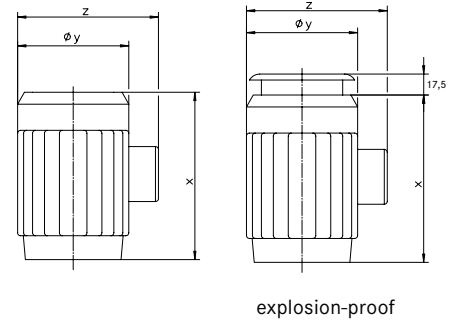
part no.	rpm	capacity [kW]	X [mm]	Y [mm]	Z [mm]
10-001 01 590	750	0,75	343,50	198	318,5
10-001 01 591	750	1,1	378,50	198	319
10-001 03 443	1.000	0,75	305	178	291
10-001 03 445	1.000	1,1	345	178	291,50
10-001 01 588	750	0,75	343,50	198	264
10-001 01 589	750	1,1	343,50	198	265
10-001 03 442	1.000	0,75	305	178	215
10-001 03 444	1.000	1,1	345	178	215,5
10-001 01 592	750	0,95	328,50	195	263
10-001 01 119	1.000	0,75	274	177	245
10-001 01 120	1.000	1,1	299	177	245



Compressed-air motors

type	rpm	capacity [kW]	X [mm]	connection D
FPM 4 Ex 	1.000	0,5	117	G 3/8
FPM 6 Ex 	1.000	1,1	155	G 1/2
FPM 8 Ex 	1.000	1,8	177	G 1/2

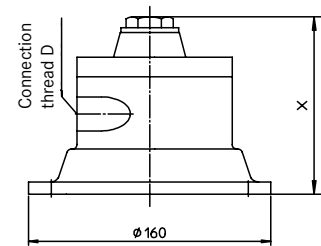

Accessories

Outlet adapter, FKM seal

	part no.
clamp 2" to G 1/2 AG	11-000 00 159
clamp 2" to G 1 AG	11-000 00 160
clamp 2" to G 1 1/2 AG	11-000 00 161
clamp 2" to RD 58x1/2 AG	11-000 00 162
clamp 2" to RD 65x1/2 AG	11-000 00 163



Performance charts

Performance chart VISCOPOWER at 1 mPas with PTFE stator

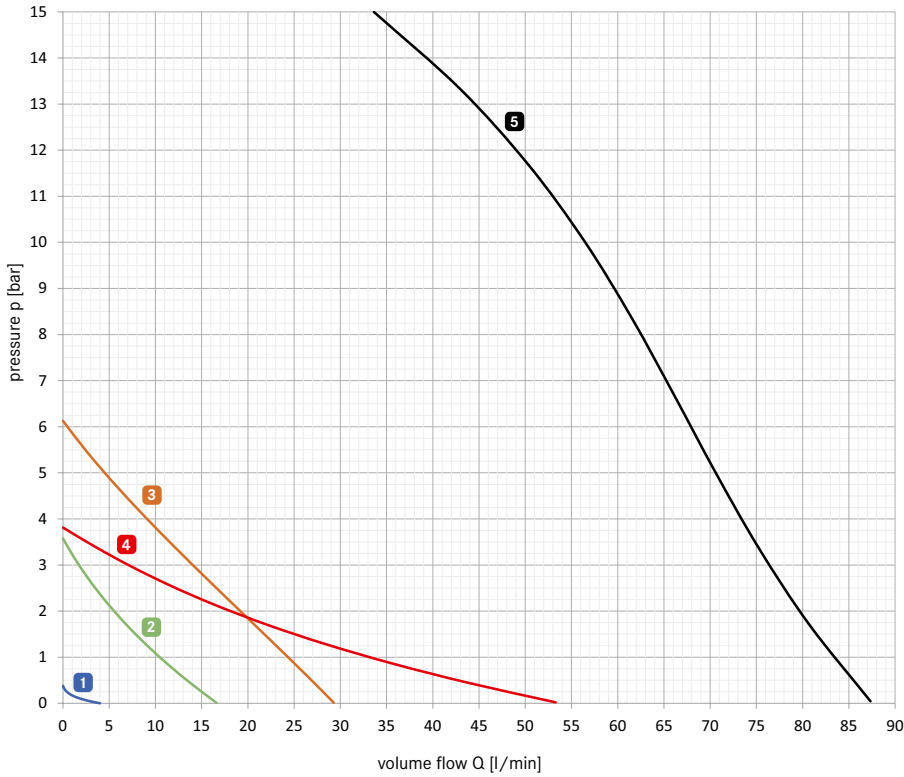

rotor/stator geometry	rpm
1	R17, 250
2	R17, 1.000
3	R33, 1.000
4	R52, 1.000
5	R83, 1.000

Performance chart VISCOPOWER at 1.000 mPas with PTFE stator

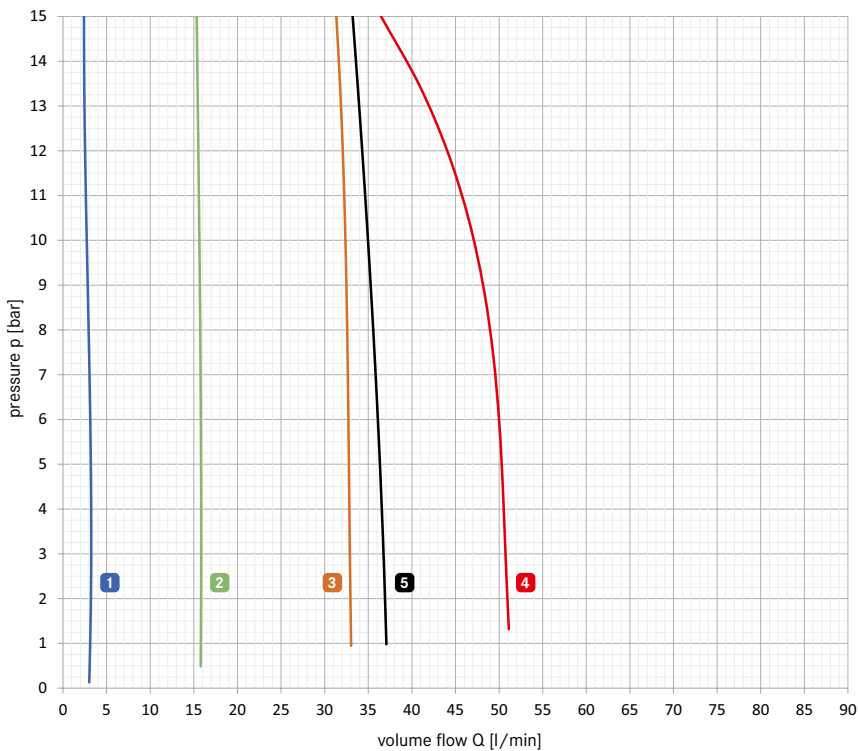

rotor/stator geometry	rpm
1	R17, 250
2	R17, 1.000
3	R33, 1.000
4	R52, 1.000
5	R83, 500

Performance charts

Performance chart VISCOPOWER at 3.000 mPas with PTFE stator

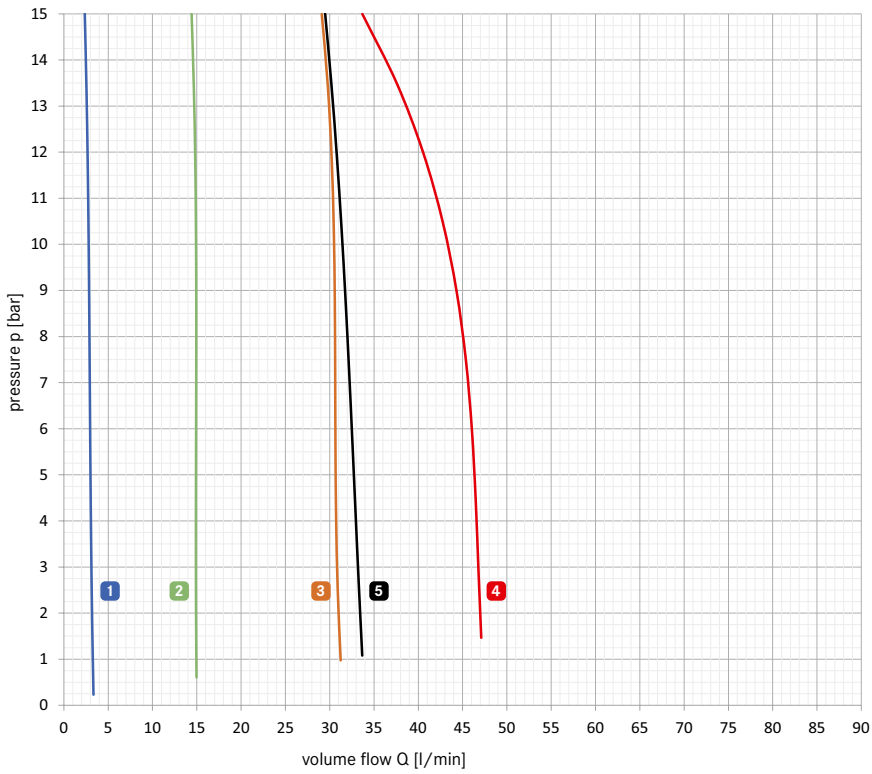

rotor/stator geometry	rpm
1	250
2	1.000
3	1.000
4	1.000
5	500